

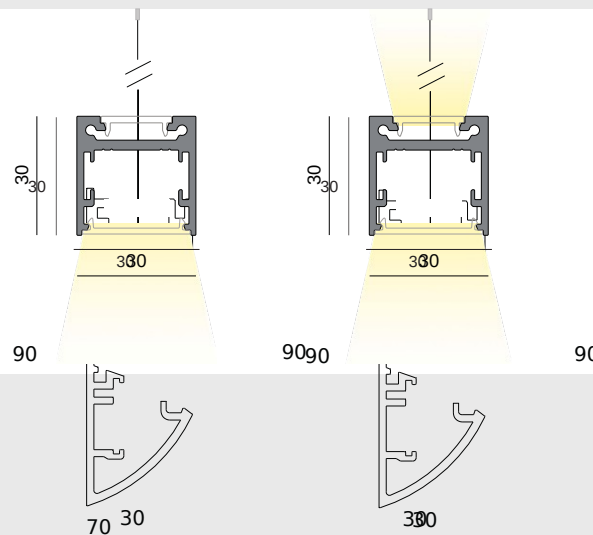

FILE 30

SUSPENSION



AVAILABLE VERSION

● KELVIN

27 2700K

30 3000K

40 4000K

● DIFFUSORE/FUSER



P Diffusore in policarbonato bianco opale |
White opal polycarbonate



X Microprismatic *

* Diffusore microprismatico a luminanza controllata
(conforme alla normativa EN 12464-1). | Microprismatic
diffuser controlled luminance (conform to standard EN
12464-1).

FINITURA/



/01 bianco | white



/02 nero | black

PREMIUMFINISHING



/81 shine pink gold



/82 bronze



/83 brushed brass

SUSPENSION

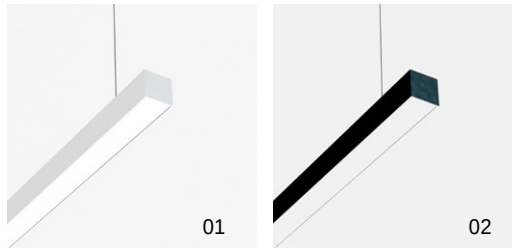
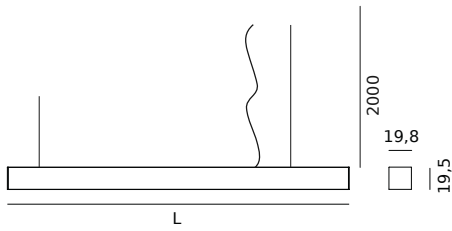

MONO EMISSION DIRECT AND
DIFFUSED LIGHT



linear di luce - LED line

W	L.mm	Kg	lm. prod/3000K	CODE
21W	964	0,70	1958	F3031.8 /##
27,7W	1264	0,90	2611	F3032.8 /##
34,3W	1564	1,10	3263	F3033.8 /##

DOUBLE EMISSION DIRECT AND
INDIRECT LIGHT



linear di luce - LED line

W	L.mm	Kg	lm. prod/3000K	CODE
21W+9W	964	0,70	1958	F3041.8 /##
27,7W+13,2W	1264	0,90	2611	F3042.8 /##
34,3W+16,8W	1564	1,10	3263	F3043.8 /##

ACCESSORI

/ LINEAR CANOPY FOR A UNIQUE TURNING ON

POWER CABLE KIT WITH CEILING CANOPY AND DRIVER INCLUDED



W	Dim.	H	CODE
30	355x32x40	2000	MFH00SA/01
60	355x32x40	2000	MFH00SB/01

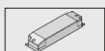

DRIVERS VEDI | P.447

24V

FILE 30

SISTEMA SOSPENSIONE

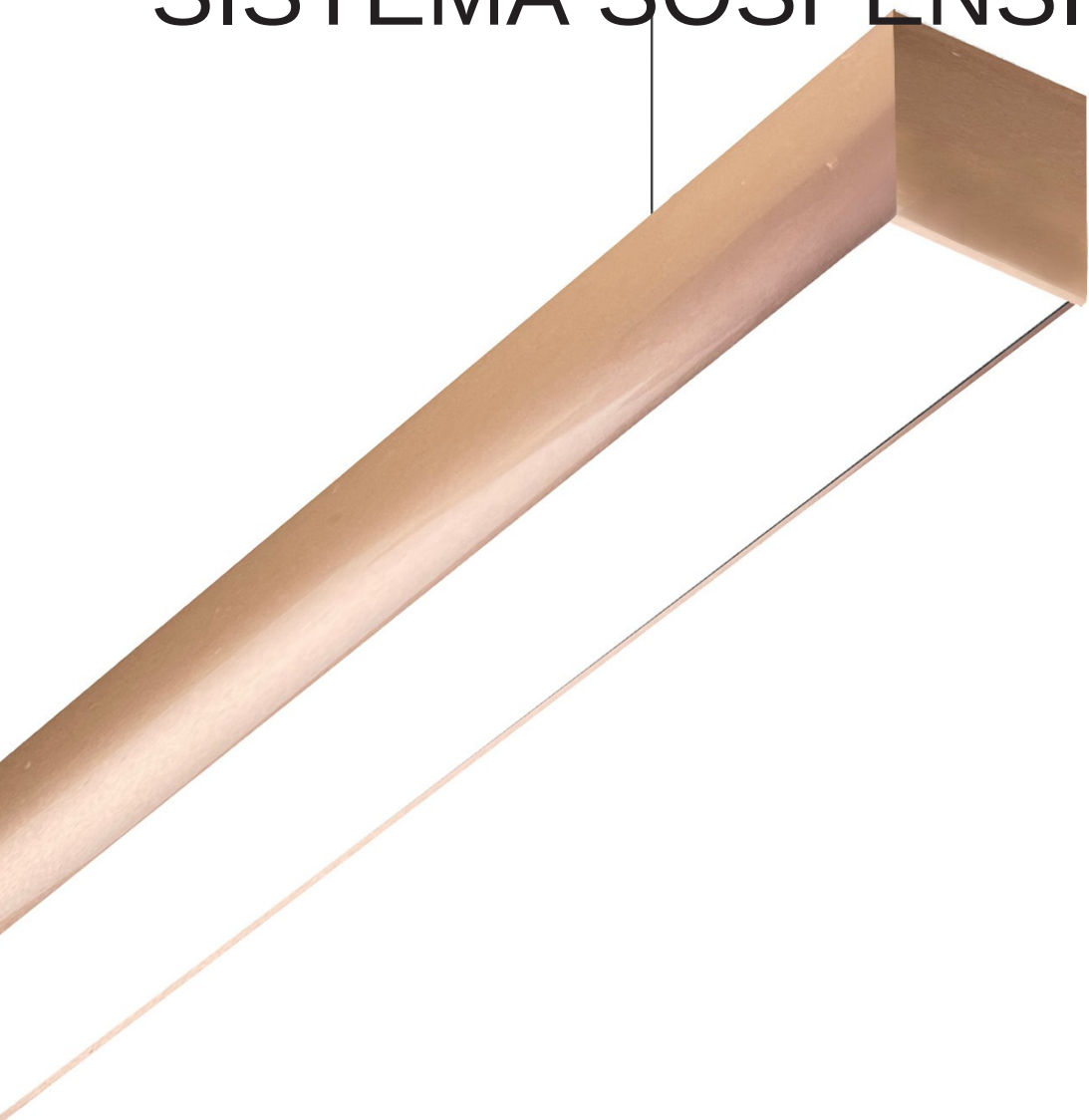

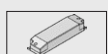

ELEMENTI LUMINOSI ELEMENTI 73





SEEP.447

FINISHING

-  **/01** bianco | white
-  **/02** nero | black

PREMIUM FINISHING

-  **/81** shine pink gold
-  **/82** bronze
-  brushed brass

SUSPENSION EMPTY PROFILE

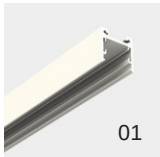

L.mm	Kg	CODE
1000	0.93	F310.1000/##
2000	1.86	F310.2000/##
3000	2.79	F310.3000/##
-----		F310.misura/##

/ COUPLE OF CLOSURE HEADS



CODE
F3121/##

LINEAR JOINT COUPLE



CODE
LTM211

ANGLE JOINT COUPLE



CODE
LTM211.90

POWER CABLE KIT WITH CEILING CANOPY



Dim.	H	CODE
62x40x45	2000	MFH01S/##

SUSPENSION KIT WITH MILLIMETER REGULATOR



H	CODE
2000	F3122

OPAL WHITE DIRECT DIFFUSER



L.mm	Kg	CODE
1000	0.14	F311A000
2000	0.31	F311A2000
3000	0.46	F311A3000
-----		F311Amisura

DIFFUSORE DIRETTO MICROPRISMATICO MICROPRISMATIC POLYCARBONATE DIFFUSER

Diffusore microprismatico a luminanza controllata (conforme normativa EN 12464-1) | Controlled luminance microprismatic diffuser (conforms to standard EN 12464-1)



L.mm	Kg	CODE
1000	0.14	F311X000
2000	0.31	F311X2000
3000	0.46	F311X3000
-----		F311Xmisura

OPAL WHITE INDIRECT DIFFUSER



L.mm	Kg	CODE
1000	0.14	MF00A000
2000	0.31	MF00A2000
3000	0.46	MF00A3000
-----		MF00Amisura