



220~240V - 50~60Hz

09/03/2021 - Rev00 - LC

IP40



Akoya F61

Important note
Note importanti
Remarques importantes
Wichtige Bemerkungen
Notas importantes

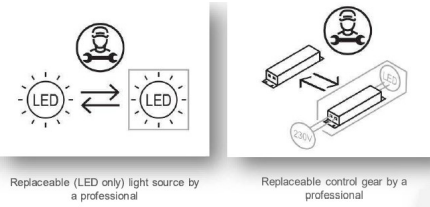

Replaceable (LED only) light source by a professional

Replaceable control gear by a professional

Always disconnect the power supply before installing the fixture or performing maintenance on it.
Prima di procedere all'installazione o alla manutenzione disinserire sempre l'energia elettrica.
Avant d'effectuer les opérations d'installation ou d'entretien, débranchez toujours l'appareil du réseau électrique.
Vor Installations- oder Wartungsarbeiten immer den Strom abschalten.
Antes de proceder a la instalación o al mantenimiento, desconectar siempre la energía eléctrica.

This fixture must be installed by a qualified electrician.
L'apparecchio deve essere installato da personale qualificato.
L'appareil doit être installé par du personnel qualifié.
Die Installation des Geräts darf ausschließlich von Fachpersonal durchgeführt werden.
El aparato debe ser instalado por personal cualificado.

Unauthorized alterations to or tampering with the product will invalidate the warranty.
Modifiche o manomissioni del prodotto, non autorizzate dall'azienda, annullano ogni condizione di garanzia.
Toute modification ou altération du produit, non autorisée par le fabricant, annule toutes les conditions de garantie.
Bei nicht vom Hersteller genehmigten Änderungen oder sachwidriger Verwendung des Produkts erlischt jeglicher Gewährleistungsanspruch.
Las modificaciones o manipulaciones del producto que no estén autorizadas por el fabricante anulan todas las condiciones de garantía.

Fabbian Srl will not be held responsible if its fixtures are not installed in accordance with local standards.
L'azienda Fabbian srl declina ogni responsabilità qualora l'installazione non avvenga secondo le norme vigenti.
La société Fabbian srl décline toute responsabilité dérivant d'une installation non conforme aux normes en vigueur.
Bei normwidriger Installation übernimmt Fabbian srl keine Haftung.
Fabbian srl declina toda responsabilidad en caso de que la instalación no se realice según las normas vigentes.

Product for indoor applications.
Prodotto per uso interno.
Produit pour intérieur
Produkt für den Innenbereich.
Producto para interior.

Please read the following instructions carefully and keep for future reference.
Consigliamo di leggere con attenzione le seguenti istruzioni e di conservarle.
Lisez attentivement les instructions suivantes et conservez-les.
Bitte die folgenden Anweisungen sorgfältig durchlesen und gut aufbewahren.
Se aconseja leer con atención y conservar las siguientes instrucciones.

CE  220~240V - 50~60Hz

IP40

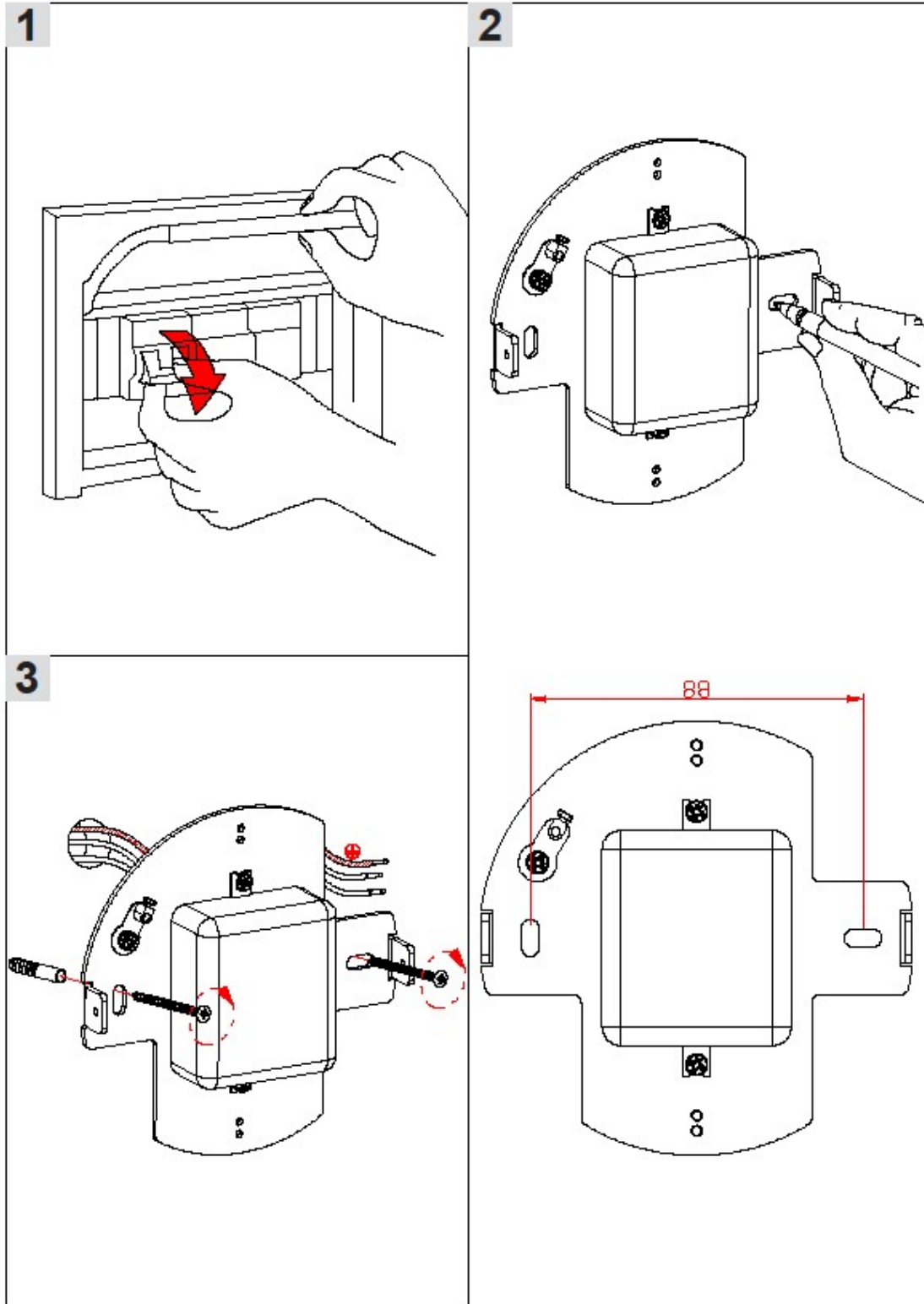

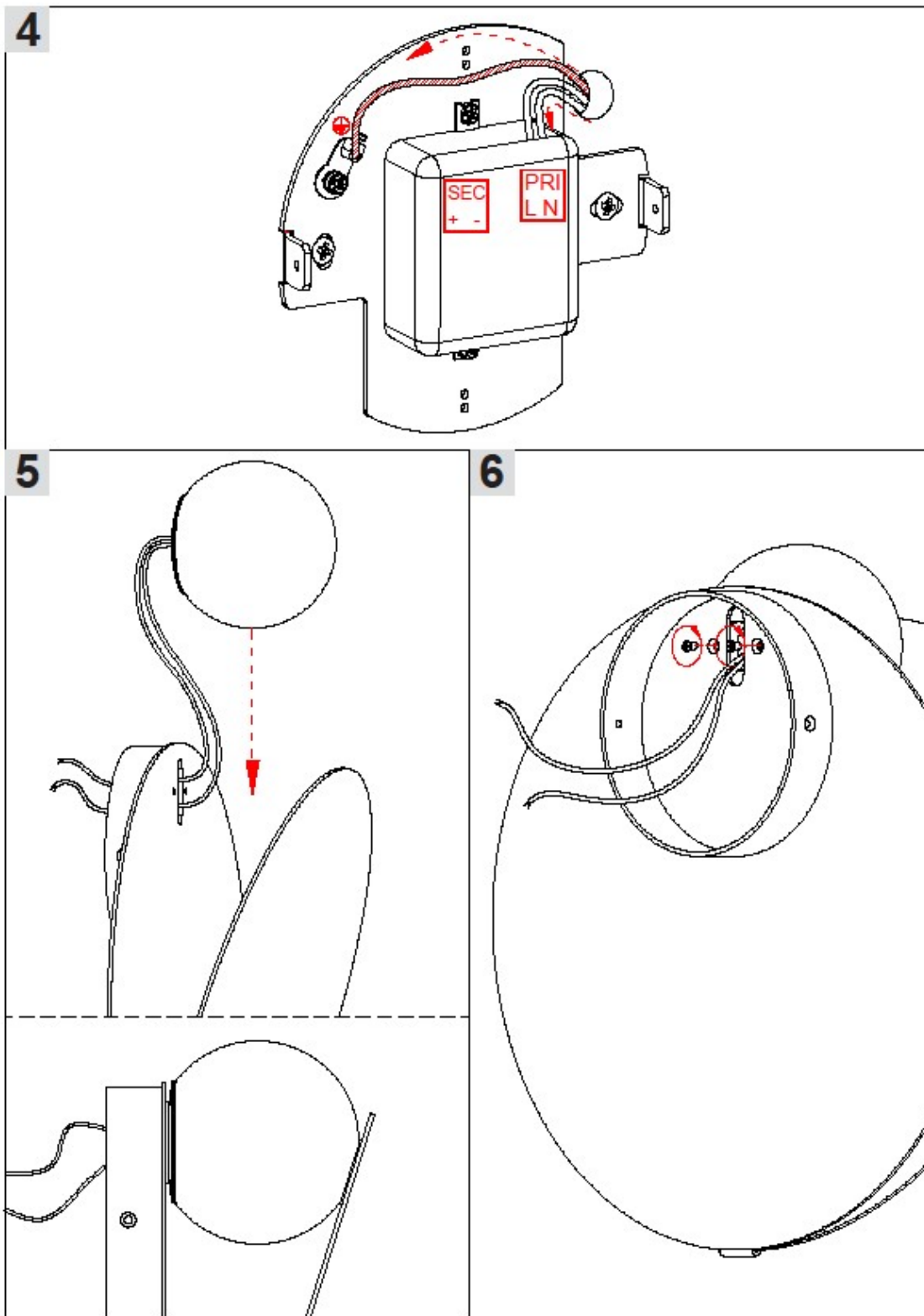

CE  220~240V - 50~60Hz

IP40



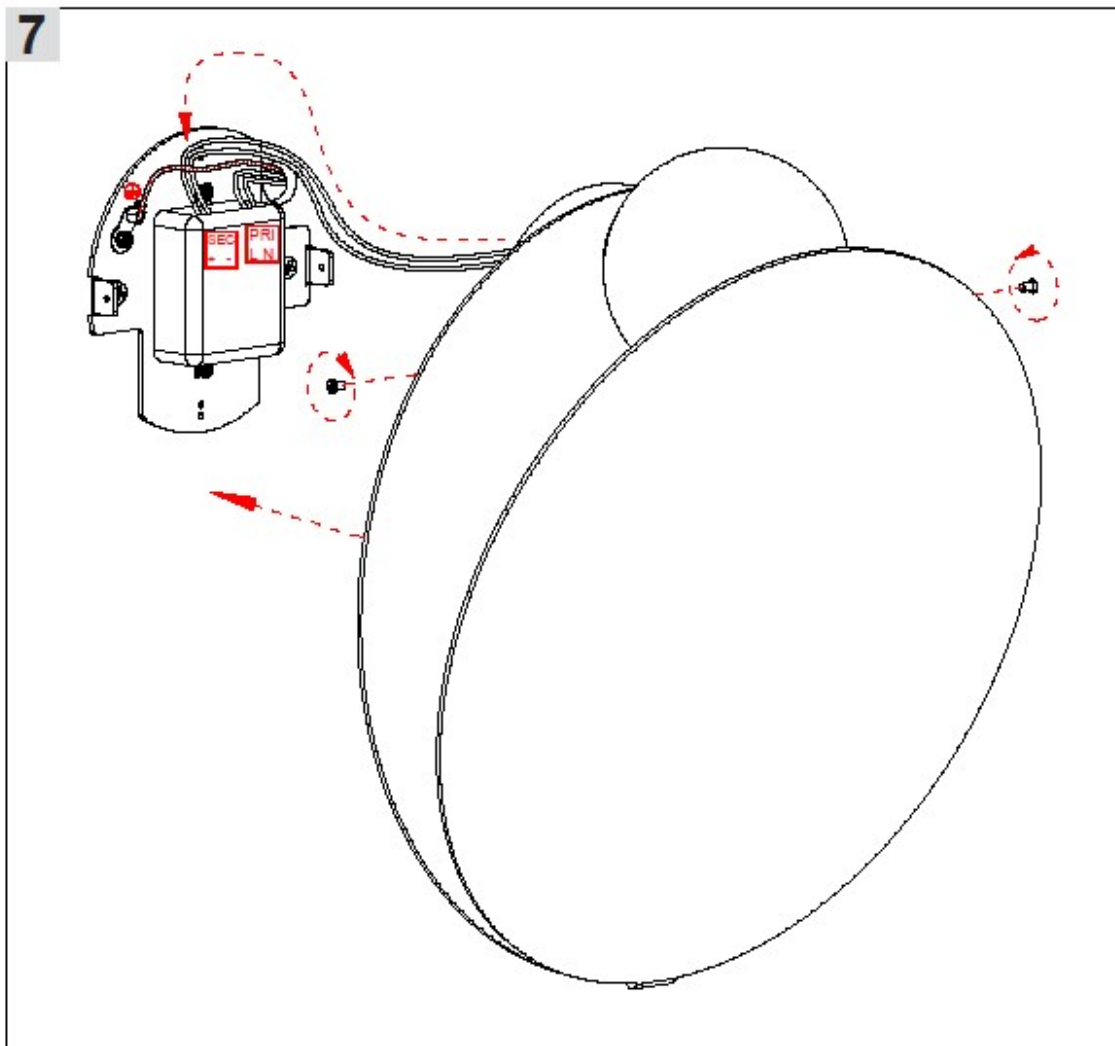

CE  220~240V - 50~60Hz

IP40   

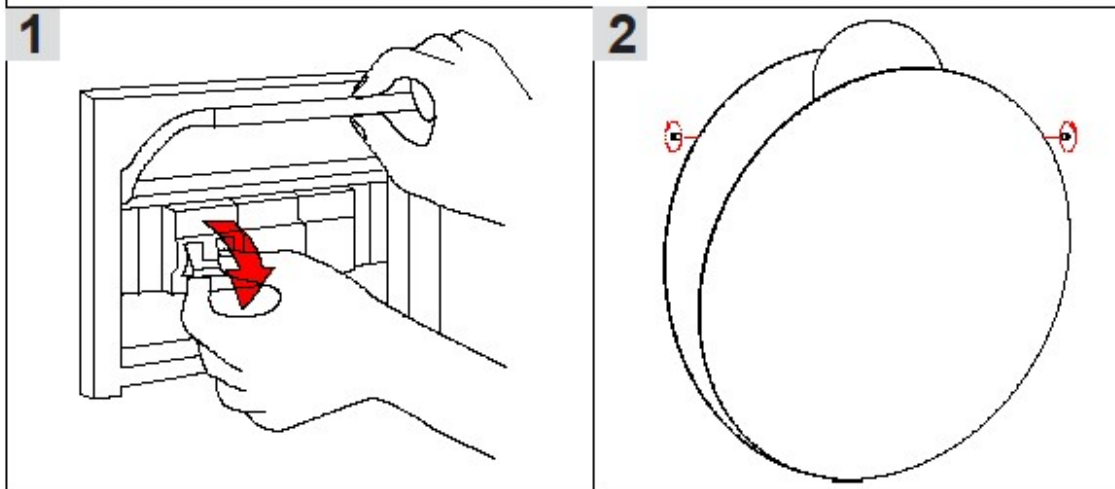

SOSTITUZIONE LED / LED REPLACEMENT



CE  220~240V - 50~60Hz

IP40

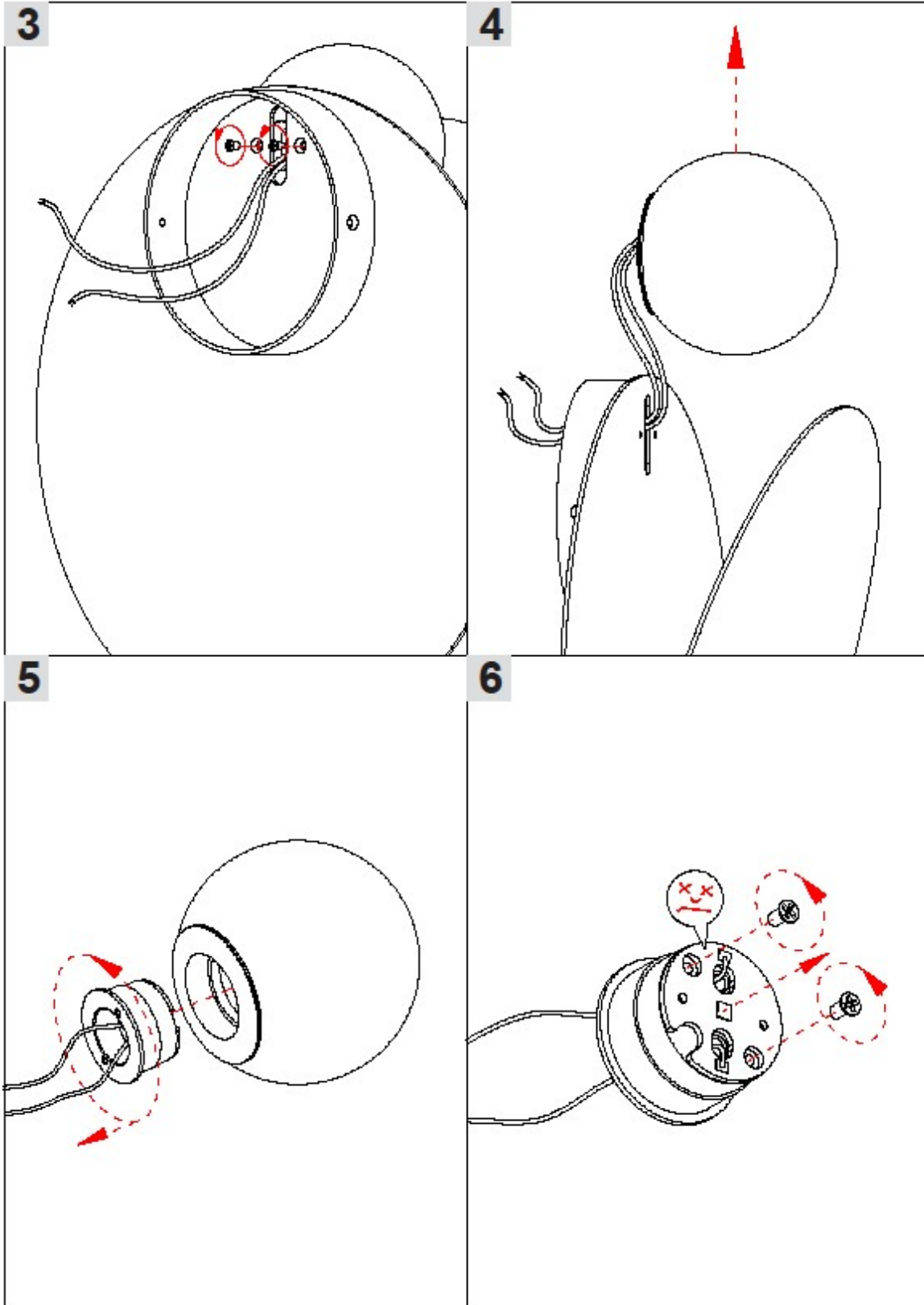

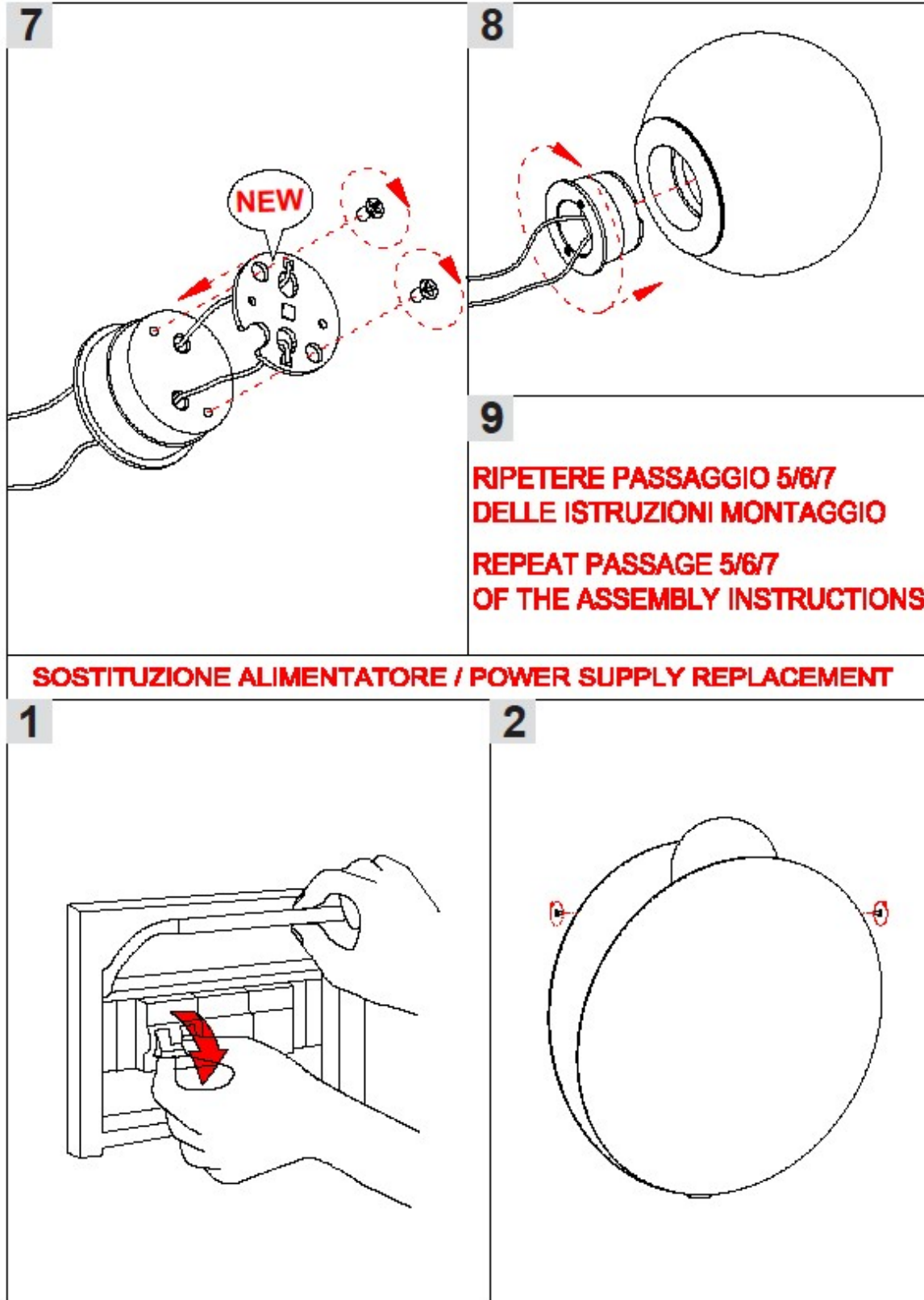

CE  220~240V - 50~60Hz

IP40

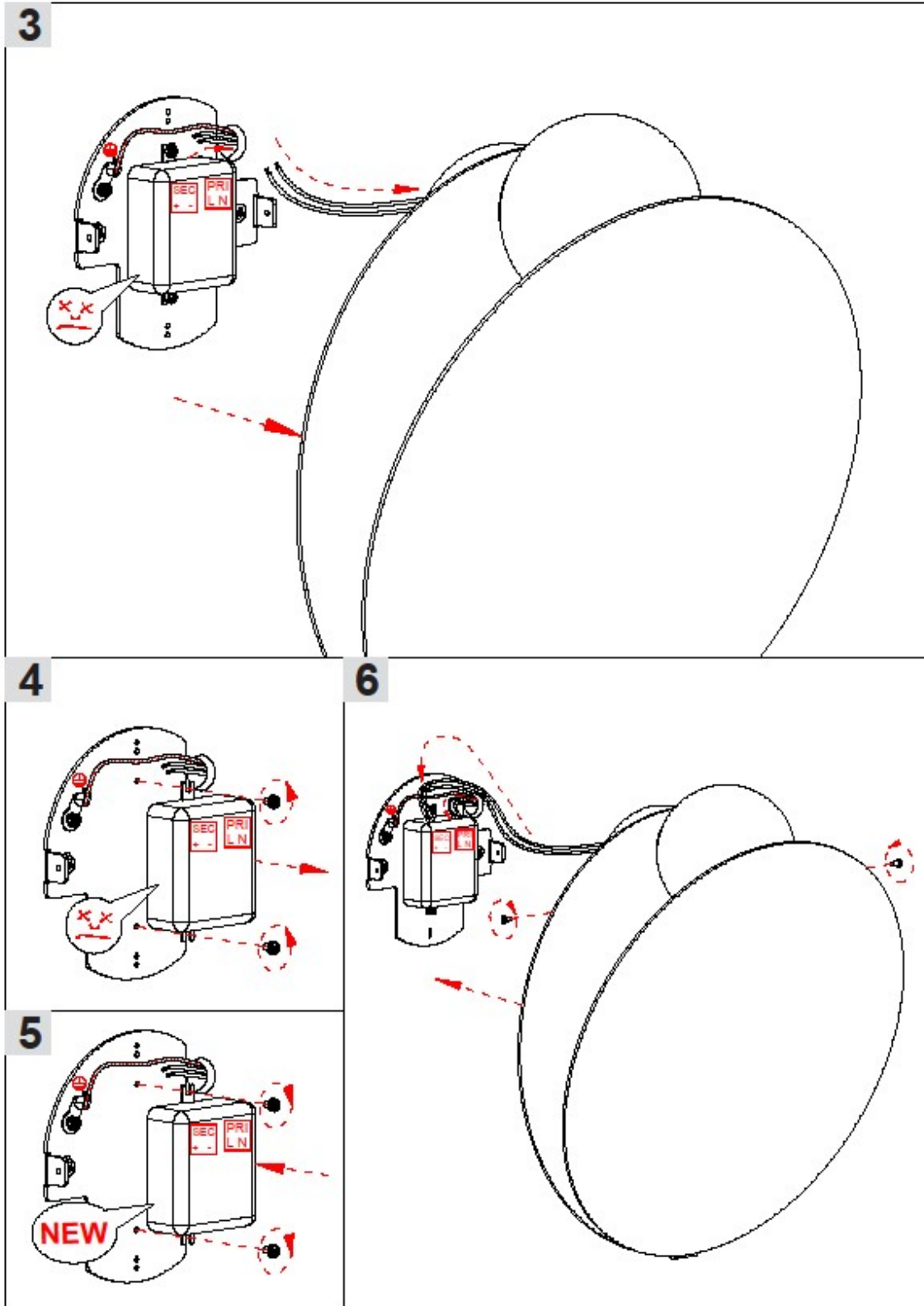

CE 220~240V - 50~60Hz

IP40

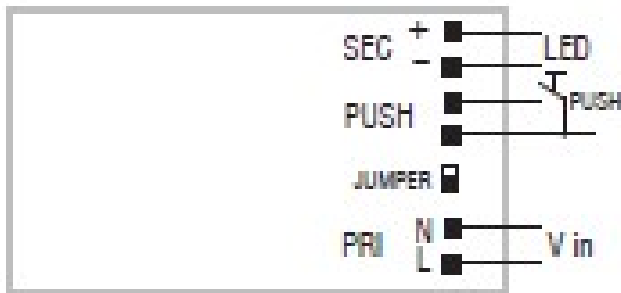

PUSH diagram - Collegamento PUSH



1...10 V diagram - Collegamento 1...10 V

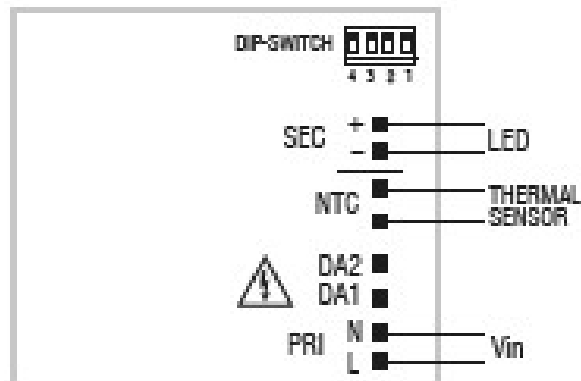

DALI diagram - Collegamento DALI