

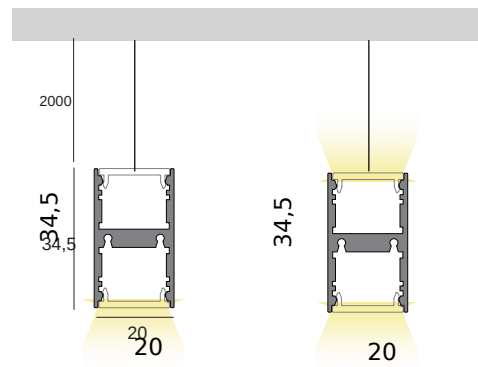

MICROFILE

SOSPENSIONE
SOSPENSIONE



Completo di diffusore in silicone | Complete with silicone diffuser

VERSIONI DISPONIBILI / AVAILABLE VERSION



● KELVIN

27 2700K



30 3000K

40 4000K

/ ## FINITURA / FINISHING

-  /01 bianco | white
-  /02 nero | black

/ ## FINITURA PREMIUM / PREMIUM FINISHING

-  /81 oro rosa shine/shine rose gold
-  /82 bronzo/ bronze
-  /83 rame spazzolato/ brushed brass

COMPOSIZIONE CODICE: ## HOW TO CREATE THE CODE: F1000.827/01

CODE

F1000.8 ● — finishing /##
base code kelvin

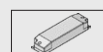

DRIVERS EDI SEEP. 447

MICROFILE H SQUARE/RECTANGULAR



		LED			
W	Dim.	Kg	lm prod	3000K	CODE
50	650x650	2,5	2425		MFH030.8##
2x50	650x650	2,5	4526		MFH040.8##
W	Dim.	Kg	lm prod	3000K	CODE
100	1200x1200	3,8	4526		MFH032.8##
2x100	1200x1200	3,8	8891		MFH042.8##
W	Dim.	Kg	lm prod	3000K	CODE
78	1200x650	3	3476		MFH031.8##
2x78	1200x650	3	6709		MFH041.8##

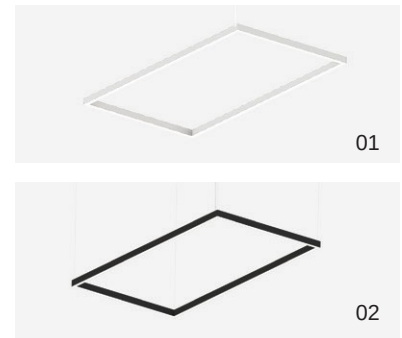

Da completare con alimentatore remoto e rosone . Possibilità di doppia accensione | To be completed with remote power supply and canopy. The fixture is suitable for double switch option

2000

MICROFILE

ELEMENTI LUMINOSI

LIGHT ELEMENTS

LINEA DI LUCE DA 5 METRI/ LED LINE 5 METERS ROLL

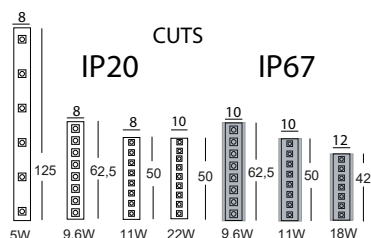

Strip led ad alta efficienza con biadesivo e supporto di larghezza 8-12 mm su bobina da 5 metri, da alimentare con driver stabilizzati in tensione da 24Vdc. Classe di isolamento III. | High efficiency strip led with biadhesive and support of 8-12 mm wide on 5 meters roll. To be fed with 24Vdc voltage-stabilized driver. Insulation class III.

Linea di luce Led IP20 24V

W/m	V	Led/m	lm/m	lm/W	CRI	IP	Lmm	CODE
5,5	24	60	270	49	80	20	5000	ST05.O.5
9,6	24	120	540	56	80	20	5000	ST10.O.5
11	24	180	1200	109	80	20	5000	ST11.O.5
22	24	168	3015	139	80	20	5000	ST22.O.5
13+13	24	80+80	2120+2230	2700-6500K	cut 50mm	20	5000	ST22.TW.5

Linea di luce Led IP67 24V

W/m	V	Led/m	lm/m	lm/W	CRI	IP	Lmm	CODE
9,6	24	120	540	56	80	67	5000	ST10.O.5IP
11	24	160	1660	151	80	67	5000	ST15.O.5IP
18	24	168	1964	109	80	67	5000	ST20.O.5IP

Linea di luce RGB- RGBW 24V

W/m	V	Led/m	lm/m	Beam	Type	CUT	Lmm	CODE
95W	24	60	270	120°	RGB + White 3000K	100	5000	ST20.RGBW.5
100W	24	120	540		RGB + White 2700K	100	5000	ST19.RGBW.5IP
100W	24	168	3015		RGB + White 2700K	100	5000	ST19.RGBW.5



VERSIONI DISPONIBILI/AVAILABLE VERSION

- KELVIN
- 27 2700K
- 30 3000K
- 40 4000K

COMPOSIZIONE CODICE: xxx.x ○ /##

HOW TO CREATE THE CODE: **F1000.827/01**

CODE

F1000.8 ○ /## — finishing

| |
base code kelvin