



ATTENZIONE:

Tutte le operazioni di montaggio, manutenzione e sostituzione lampadine, vanno eseguite assicurandosi che la rete di alimentazione sia disinserita.

ATTENTION:

Toutes les opérations de montage, entretien et remplacement des ampoules ne doivent être effectuées qu'après avoir coupé le courant.

CUIDADO:

Todas las operaciones de montaje, manutención y substitución de lámparas tienen que realizarse después de comprobar que la red de suministro está desconectada.

ACHTUNG:

Montage, Wartung und Lampenwechsel dürfen nur nach Unterbrechung des Netzanschlusses durchgeführt werden.

WARNING:

when carrying out all assembly, maintenance and bulbs replacement operations, make sure that the supply is OFF.

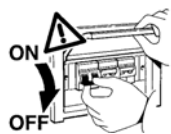

ATTENZIONE:

La sicurezza dell'apparecchio è garantita con l'uso appropriato delle istruzioni. Pertanto è necessario conservarle.

ATTENTION:

La sûreté de l'appareil est garantie avec l'utilisation appropriée des instructions. Il est donc nécessaire de les garder.

CUIDADO:

La seguridad del aparato está garantizada se si hace el uso apropiado de las siguientes instrucciones. Por lo tanto es necesario conservarlas.

ACHTUNG:

Die Sicherheit des Gerätes ist nur garantiert, wenn die folgenden Vorschriften eingehalten werden. Es ist daher notwendig diese aufzubewahren.

WARNING:

The safety of the fitting is guaranteed by the correct use of the instructions. It is therefore necessary to keep them.

ELECTRICAL CONNECTION ⚠

1 LED DRIVER LED 700 mA

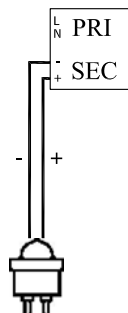

2 LED DRIVER LED 700 mA

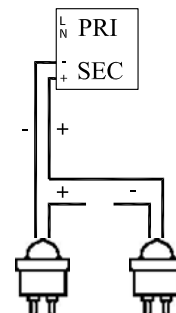

Il seguente prodotto LED è stato testato e risulta perfettamente funzionante. Porre la massima attenzione alla polarità (+, cavo rosso/-, cavo nero) di connessione per non provocare danni. **Connessione LED in serie.** In fase di sostituzione dei LED scollegare sempre l'alimentatore dalla rete elettrica.

The LED products has been tested and results perfectly working. Pay maximum attention to the polarity (+, red cable/-, black cable) of the electric connection in order to avoid damages. **LED connection in series.** While replacing the LED bulb, always disconnect the driver from the electric network.

PIXEL

MONTAGGIO A SOFFITTO

Ceiling mounting

Deckenanbringung

1x8.5W 700mA

LED White

Remote constant current

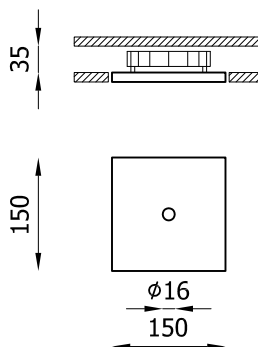

1007.AC 4 R _ E _ WD

lens

- 15 15°
- 25 25°
- 45 45°

light colour

- 27 2700K
- 30 3000K
- 40 4000K

Per difetti riscontrati indicare il numero di controllo.

En cas de défauts mentionner le numéro de contrôle.

En caso de defectos hacer mención del número de control.

Für eventuell festgestellte Mängel bitte die Kontrollnummer angeben.

For any manufacturing defect refer to the check number.

- Controllo
- Contrôle
- Control
- Kontrolle
- Control

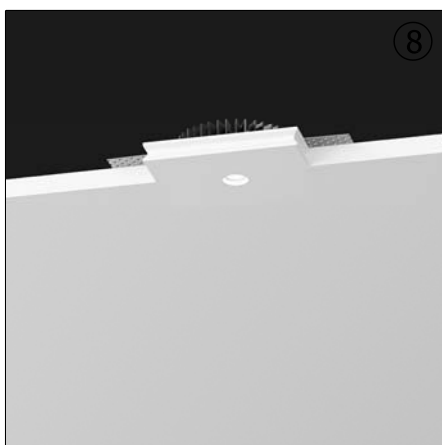
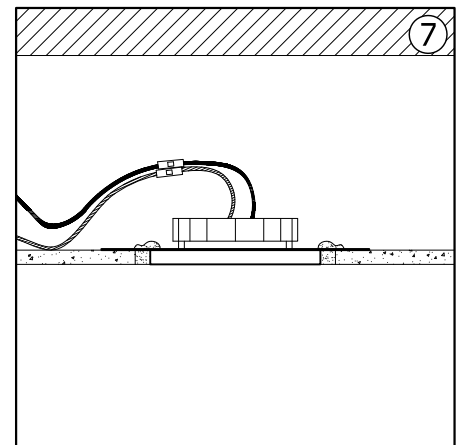
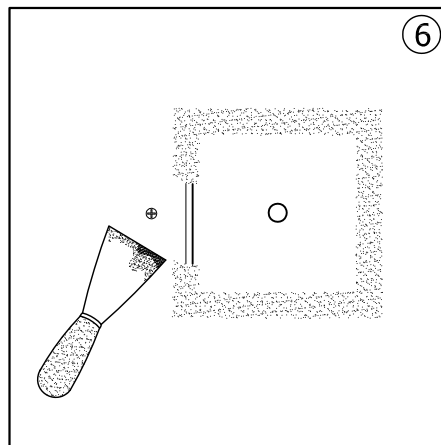
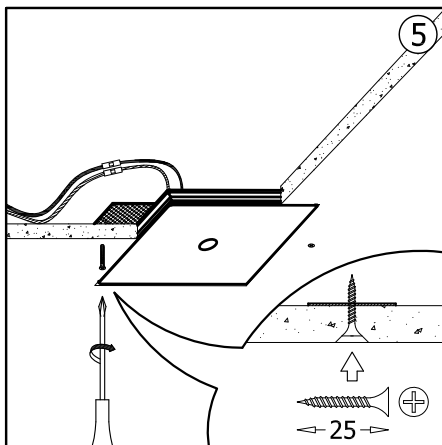
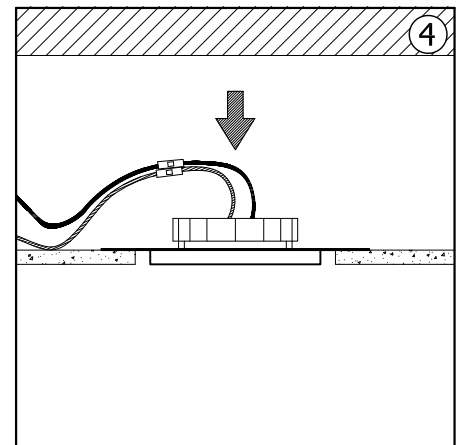
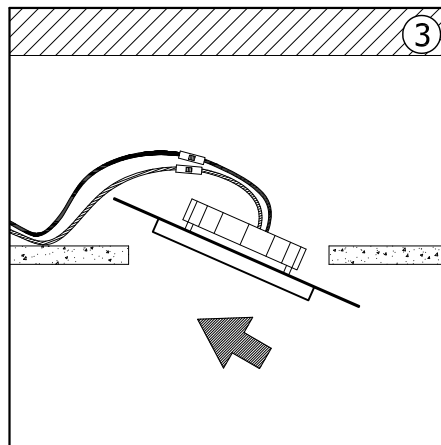
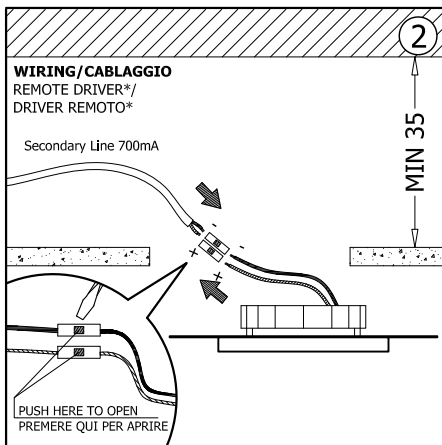
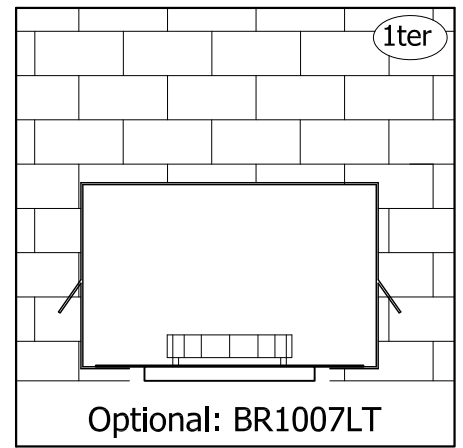
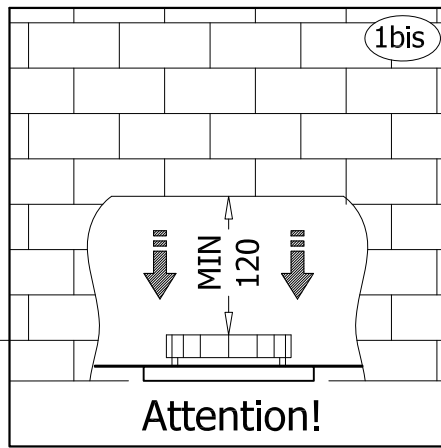
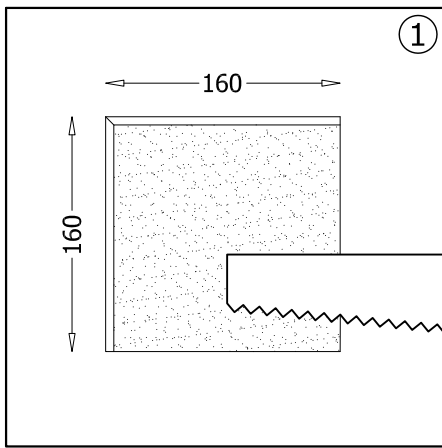

*Optional
H8700.E LED Driver 700mA 220-240V · 50/60Hz
Constant current electronic driver. Remote installation. Suitable for n°1 or n°3 code 1007.AC

*Optional
H8700.E LED Driver 700mA 220-240V · 50/60Hz
Driver elettronico a corrente continua. Installazione remota. Adatto a n°1 o n°3 1007.AC

MAINTENANCE - MANUTENZIONE

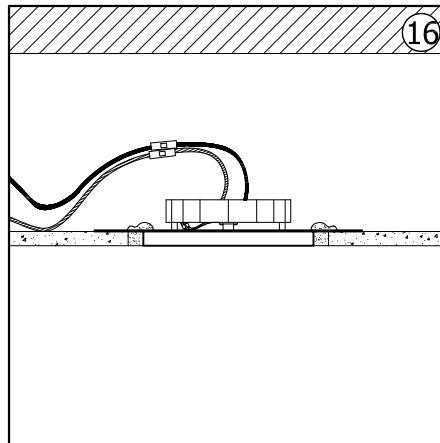
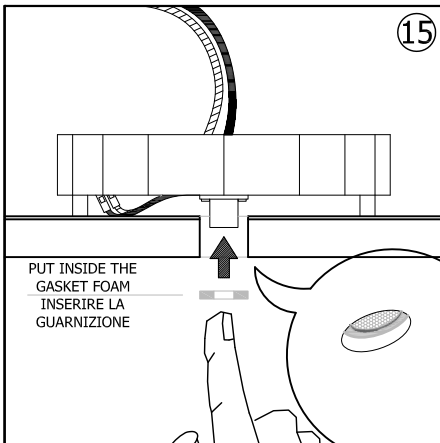
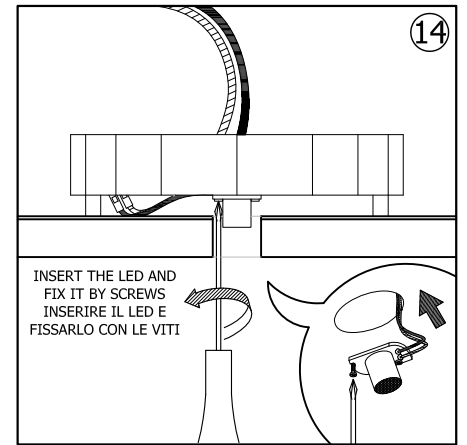
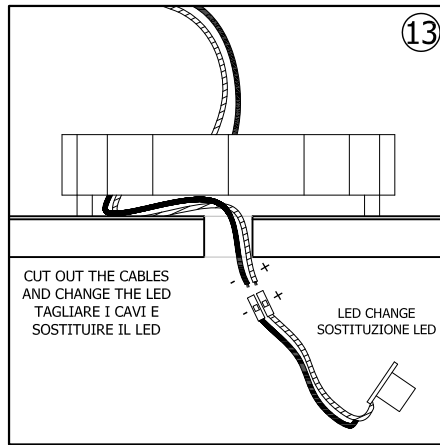
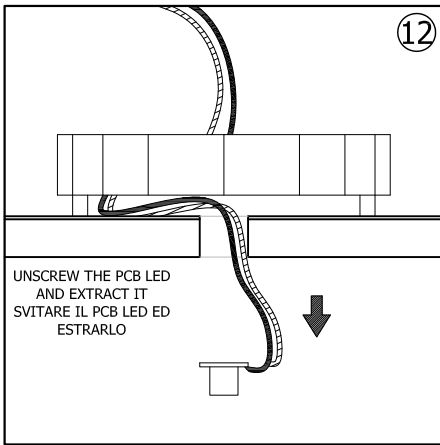
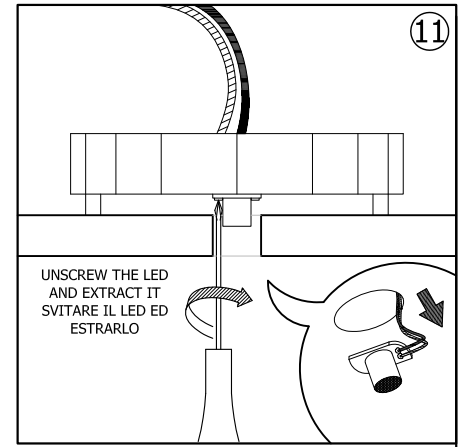
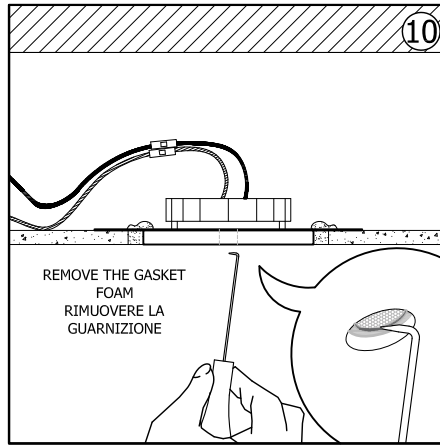
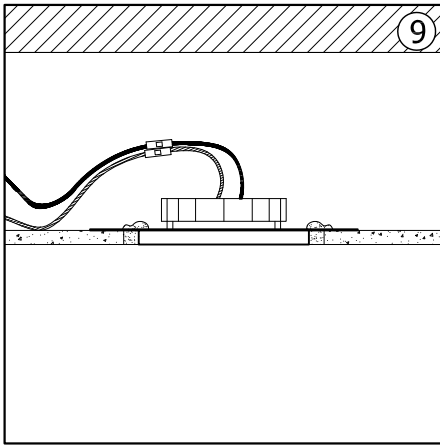

AVVERTENZE - WARNING - WARNUNG

- Per i collegamenti utilizzare alimentatori elettronici certificati.
- For the connection use certified electronic ballast.
- Für die Schaltung zertifizierte elektronischem Vorschaltgerät



- Non ricoprire l'apparecchio con materiale isolante o similare.
- Do not cover the box with fiberglass or other kind of material.
- Das Gehäuse nicht mit Glasfaser oder anderem Material bedecken.

- In caso di installazione in laterizio lasciare 120 mm di aria posteriormente al prodotto. La scatola del cablaggio non deve in alcun modo essere coperta.
- In case of installation in brick leave 120 mm of free space behind the product. The connection box shall absolutely not be covered.
- Bei einem Einbau in Ziegelstein 120 mm Platz Hinter dem Produkt lassen. Der Anschlusskasten darf auf keinen Fall bedeckt sein.

- Mantenere tra il bordo dell'apparecchio e le pareti dove viene incassato almeno 50 mm.
- Keep at least 50 mm of distance between the border of the fitting and the recessed surfaces.
- Zwischen Leuchtenrand und Einbauwänden mindestens 50 mm Abstand halten.

- La sorgente luminosa contenuta in questo apparecchio deve essere sostituita esclusivamente dal costruttore, dal suo servizio di assistenza o da personale qualificato equivalente.
- The light source in this fitting must be replaced only by the manufacturer, its assistance service or by personnel with equivalent qualifications, in order to avoid the risk of danger.
- Die Lichtquelle in diesem Gerät darf nur vom Hersteller, seinem Kundendienst oder vom entsprechenden Fachpersonal ausgetauscht werden, um Gefahren zu vermeiden.

- Il prodotto è in classe di rischio 1 (basso rischio) in accordo con la EN62471
- The product falls in risk class 1 (low risk) in accordance with EN 62471.
- Das Produkt ist in der Risikoklasse 1 eingestuft (niedriges Risiko) und entspricht EN 62471.

LED

- Utilizzare convertitori in corrente costante 700 mA.
- Use output converter in steady current 700mA.
- Ausgang in Konstantstrom verwenden 700mA

- Informazioni tecniche: per lunghezza massima dei cavi tra convertitore e modulo LED contattare l'azienda.
- Technical information: for max. cable length between converter and LED module please contact the company.
- Technische Information: für Empfohlene max. Kabellänge zwischen Konverter und LED Modul bitte kontaktieren Sie das Unternehmen.

- Attenzione: Rispettare la polarità.
- Attention: Respect the polarity.
- Achtung: Polarität einhalten.

- Porre la massima attenzione alla polarità (+, cavo rosso/-, cavo nero) di connessione per non provocare danni.
Connessione LED in serie.
- Pay maximum attention to the polarity (+, red cable/-, black cable) of the electric connection in order to avoid damages.
LED connection in series.
- Faire maximale attention à la polarité (+, câble rouge/-, câble noir) de la connexion électrique pour non provoquer des dommages.
Connexion LED en série.
- Zur Vermeidung von Schäden, die Polarität (+, rotes Kabel/-, schwarzes Kabel) des elektrischen Anschlusses beachten.
LED Anschluss in Serie.