

MICROFILE SISTEMA

INCASSO ARRETRATO RADENTE NEW *WALL WASHER BACK RECESSED*

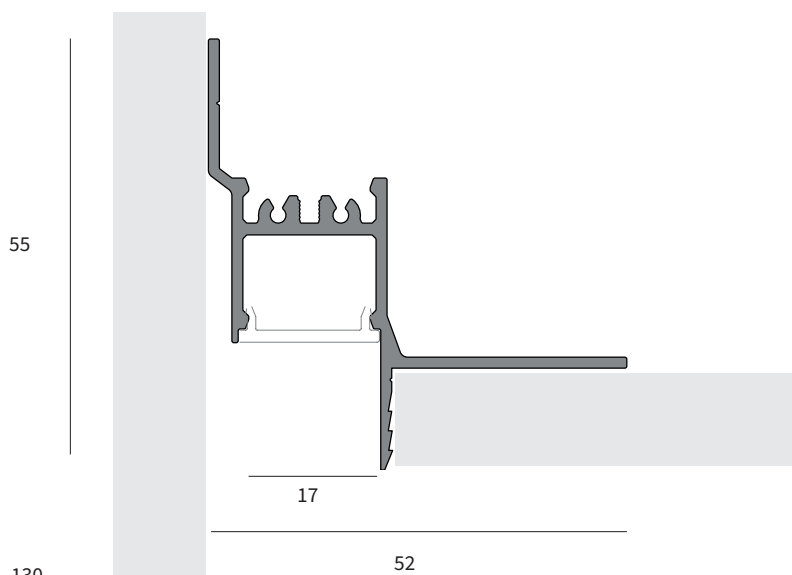

VERSIONI DISPONIBILI/AVAILABLE VERSION

COMPOSIZIONE CODICE: xxx /##

HOW TO CREATE THE CODE: **F1000/01**

CODE

F1000 /27 — finishing  alluminio | aluminium

|
base code

.misura sostituire con la misura necessaria in mm. /
replace with the required measure in mm.

PROFILO VUOTO INCASSO RASATO / TRIMLESS RECESSED EMPTY PROFILE

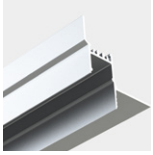

Lmm	Kg	CODE
1000	0.95	MF41.1000/27
2000	2.00	MF41.2000/27
3000	2.60	MF41.3000/27
-----		MF41.misura/27

COPPIA DI TESTATE PER PROFILO INCASSO RASATO/ COUPLE OF CLOSURE HEADS FOR TRIMLESS RECESSED PROFILE



CODE
MF41TI

DIFFUSORE IN POLICARBONATO OPALINO / OPAL WHITE POLYCARBONATE DIFFUSER

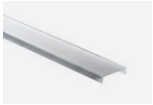

L.mm	Kg	CODE
1000	0.16	MF00P.1000
2000	0.33	MF00P.2000
3000	0.50	MF00P.3000
-----		MF00P.misura

DIFFUSORE IN SILICONE / SILICONE DIFFUSER

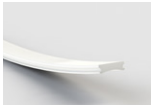

CODE
MFH00TH.misura

Lunghezza massima 20 m - Maximum length 20m



ELEMENTI LUMINOSI /LIGHT ELEMENTS P. 138

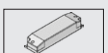

DRIVERS VEDI | SEE P. 447

MICROFILE

SISTEMA SOFFITTO

CEILING SYSTEM



TUTTOLINGUE CATANIA
ARCH. DARIO ANTIGNANO

19,5

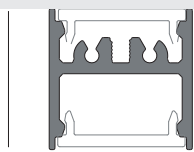

19,8

VERSIONI DISPONIBILI/AVAILABLE VERSION

/ ## FINITURA/FINISHING



/01 bianco | white

/02 nero | black

/ ## FINITURA PREMIUM /PREMIUM FINISHING

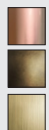

/81 oro rosa shine/shine rose gold

/82 bronzo/ bronze

/83 ottone spazzolato/ brushed brass

COMPOSIZIONE CODICE: xxx.x /##

HOW TO CREATE THE CODE: **F1000/01**

CODE

F1000 /## — finishing

|
base code

.misura sostituire con la misura necessaria in mm. /
replace with the required measure in mm.

PROFILO VUOTO / EMPTY PROFILE



Lmm	CODE
1000	MF01.1000/##
2000	MF01.2000/##
3000	MF01.3000/##
----	MF01.misura/##

Profilo completo di diffusore in policarbonato - Polycarbonate diffuser included.

COPPIA DI TESTATE DI CHIUSURA / COUPLE OF CLOSURE HEADS



CODE
MF00TP/##

SISTEMA D'AGGANCIO / FIXING SYSTEM



Lmm	CODE
1000	MF00DP.1000
2000	MF00DP.2000
3000	MF00DP.3000

DIFFUSORE IN POLICARBONATO OPALINO / OPAL WHITE POLYCARBONATE DIFFUSER



L.mm	Kg	CODE
1000	0.16	MF00P.1000
2000	0.33	MF00P.2000
3000	0.50	MF00P.3000
-----		MF00P.misura

DIFFUSORE IN SILICONE / SILICONE DIFFUSER



CODE
MFH00TH.misura

Lunghezza massima 20 m - Maximum length 20m

GIUNTO LINEARE / LINEAR JOINT



Lmm.	CODE
2000	MF03.GL



ELEMENTI LUMINOSI /LIGHT ELEMENTS P. 138

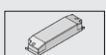

DRIVERS VEDI | SEE P. 447

MICROFILE

SISTEMA SOSPENSIONE

SUSPENSION SYSTEM

IZAKAYA JAPANESE RESURANT SYDNEY
PROJECT MICHIRU DESIGN STUDIO

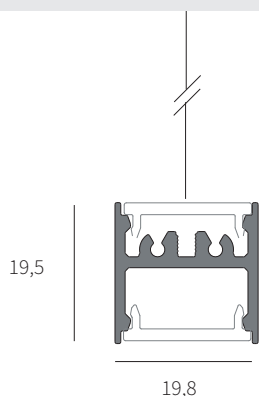

VERSIONI DISPONIBILI/AVAILABLE VERSION

/ ## FINITURA/FINISHING



/01 bianco | white



/02 nero | black

/ ## FINITURA PREMIUM /PREMIUM FINISHING



/81 oro rosa shine/shine rose gold



/82 bronzo/ bronze



/83 ottone spazzolato/ brushed brass

COMPOSIZIONE CODICE: xxx.x /##

HOW TO CREATE THE CODE: F1000/01

CODE

F1000 /## — finishing

|
base code

.misura sostituire con la misura necessaria in mm. /
replace with the required measure in mm.

PROFILO VUOTO / EMPTY PROFILE



Lmm	CODE
1000	MF01.1000 / ##
2000	MF01.2000/ ##
3000	MF01.3000/ ##
----	MF01.misura/ ##

Profilo completo di diffusore in policarbonato - Polycarbonate diffuser included.

COPPIA DI TESTATE DI CHIUSURA / COUPLE OF CLOSURE HEADS



CODE
MF00TP/##

MOLLA SINGOLA PER CARTONGESSO / SINGLE SPING FOR FALSE CEILING



CODE
MF02.SF

Molla singola per fissare il profilo lineare al controsoffitto. Una ogni metro, minimo 2 | Single spring for fixing the linear profile on the false-ceiling. One every meter, 2 pieces minimum.

DIFFUSORE IN SILICONE / SILICONE DIFFUSER



CODE
MFH00TH.misura/##

Lunghezza massima 20 m - Maximum lenght 20m

KIT ALIMENTAZIONE SOSPENSIONE CON ROSONE E DRIVER INCLUSI POWER CABLE KIT WITH CEILING CANOPY AND DRIVER INCLUDED



W	Dim.	H	CODE
30	355x32x40	2000	MFH00SA/01
60	355x32x40	2000	MFH00SB/01



KIT ALIMENTAZIONE SOSPENSIONE CON ROSONE / POWER CABLE KIT WITH CEILING CANOPY



Dim.	H	CODE
62x40x45	2000	MFH01S/##

CAVO SINGOLO DI SOSP. IN ACCIAIO L.2000mm / STEEL SUSPENSION KIT L. 2000 mm



Lmm.	CODE
2000	MF03.SO/##

GIUNTO LINEARE / LINEAR JOINT



CODE
MF03.GL



ELEMENTI LUMINOSI /LIGHT ELEMENTS P. 138

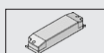

DRIVERS VEDI | SEE P. 447

MICROFILE

SISTEMA ANGOLARE

CORNER SYSTEM

INSTALLAZIONE IN ANGOLO ESTERNO
RECESSED WITHIN AN OUTSIDE CORNER

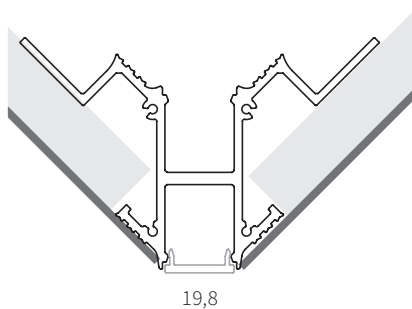

INSTALLAZIONE IN ANGOLO INTERNO
RECESSED WITHIN AN INSIDE CORNER

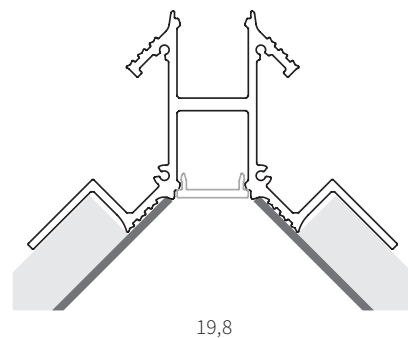

Un solo profilo due possibilità di installazione
One profile two installation options



Lmm	CODE
1000	MF04.1000/##
2000	MF04.2000/##
3000	MF04.3000/##
-----	MF04.misura/##

Profilo compreso di diffusore - Diffuser included

COPPIA TESTATE ANGOLARE / COUPLE OF CLOSURE HEADS, CORNER VERSION



CODE
MF00TA/##

GIUNTO LINEARE / LINEAR JOINT



Lmm.	CODE
2000	MF03.GL



DIFFUSORE IN POLICARBONATO OPALINO / OPAL WHITE POLYCARBONATE DIFFUSER





L.mm	Kg	CODE
1000	0.16	MF00P.1000
2000	0.33	MF00P.2000
3000	0.50	MF00P.3000
-----		MF00P.misura

VERSIONI DISPONIBILI/AVAILABLE VERSION

/ ## FINITURA/FINISHING

-  /01 bianco | white
-  /02 nero | black

/ ## FINITURA PREMIUM /PREMIUM FINISHING

-  /81 oro rosa shine/shine rose gold
-  /82 bronzo/ bronze
-  /83 ottone spazzolato/ brushed brass

COMPOSIZIONE CODICE: xxx.x /##

HOW TO CREATE THE CODE: **F1000/01**

CODE

F1000 /## — finishing

|
base code

.misura sostituire con la misura necessaria in mm. /
replace with the required measure in mm.



ELEMENTI LUMINOSI /LIGHT ELEMENTS P. 138

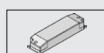

DRIVERS VEDI | SEE P. 447

MICROFILE

ELEMENTI LUMINOSI

LIGHT ELEMENTS

LINEA DI LUCE DA 5 METRI/ LED LINE 5 METERS ROLL

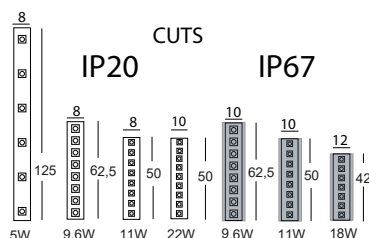

Strip led ad alta efficienza con biadesivo e supporto di larghezza 8-12 mm su bobina da 5 metri, da alimentare con driver stabilizzati in tensione da 24Vdc. Classe di isolamento III. | High efficiency strip led with biadhesive and support of 8-12 mm wide on 5 meters roll. To be fed with 24Vdc voltage-stabilized driver. Insulation class III.

Linea di luce Led IP20 24V

W/m	V	Led/m	lm/m	lm/W	CRI	IP	Lmm	CODE
5,5	24	60	270	49	80	20	5000	ST05.O.5
9,6	24	120	540	56	80	20	5000	ST10.O.5
11	24	180	1200	109	80	20	5000	ST11.O.5
22	24	168	3015	139	80	20	5000	ST22.O.5
13+13	24	80+80	2120+2230	2700-6500K	cut 50mm	20	5000	ST22.TW.5

Linea di luce Led IP67 24V

W/m	V	Led/m	lm/m	lm/W	CRI	IP	Lmm	CODE
9,6	24	120	540	56	80	67	5000	ST10.O.5IP
11	24	160	1660	151	80	67	5000	ST15.O.5IP
18	24	168	1964	109	80	67	5000	ST20.O.5IP

Linea di luce RGB- RGBW 24V

W/m	V	Led/m	lm/m	Beam	Type	CUT	Lmm	CODE
95W	24	60	270	120°	RGB + White 3000K	100	5000	ST20.RGBW.5
100W	24	120	540		RGB + White 2700K	100	5000	ST19.RGBW.5IP
100W	24	168	3015		RGB + White 2700K	100	5000	ST19.RGBW.5



VERSIONI DISPONIBILI/AVAILABLE VERSION

- KELVIN
- 27 2700K
- 30 3000K
- 40 4000K

COMPOSIZIONE CODICE: xxx.x ○ /##

HOW TO CREATE THE CODE: **F1000.827/01**

CODE

F1000.8 ○ /## — finishing

| |
base code kelvin